

AUS / NZ

### CAMBRIDGE Model: 3500 Focal Point Fire with Optiflame Plus Incorporating 2kW Fan Heater

Issue 1 8/18537/0

IMPORTANT: THESE INSTRUCTIONS SHOULD BE READ CAREFULLY AND RETAINED FOR FUTURE REFERENCE

#### Introduction

This fire incorporates a flame effect, which can be used with or without heating, so that the comforting effect may be enjoyed at any time of the year.

The flame effect is provided by low wattage motors and three 40 watt lamps. Using the flame effect on its own, therefore requires little electricity. The controls are concealed behind the ash-pan flap, control cover. A choice of 1kW or 2kW thermostatically controlled heat output is provided by the fan heater, which is concealed behind the top grille.

This model is designed to be inset in a fireplace opening suite.

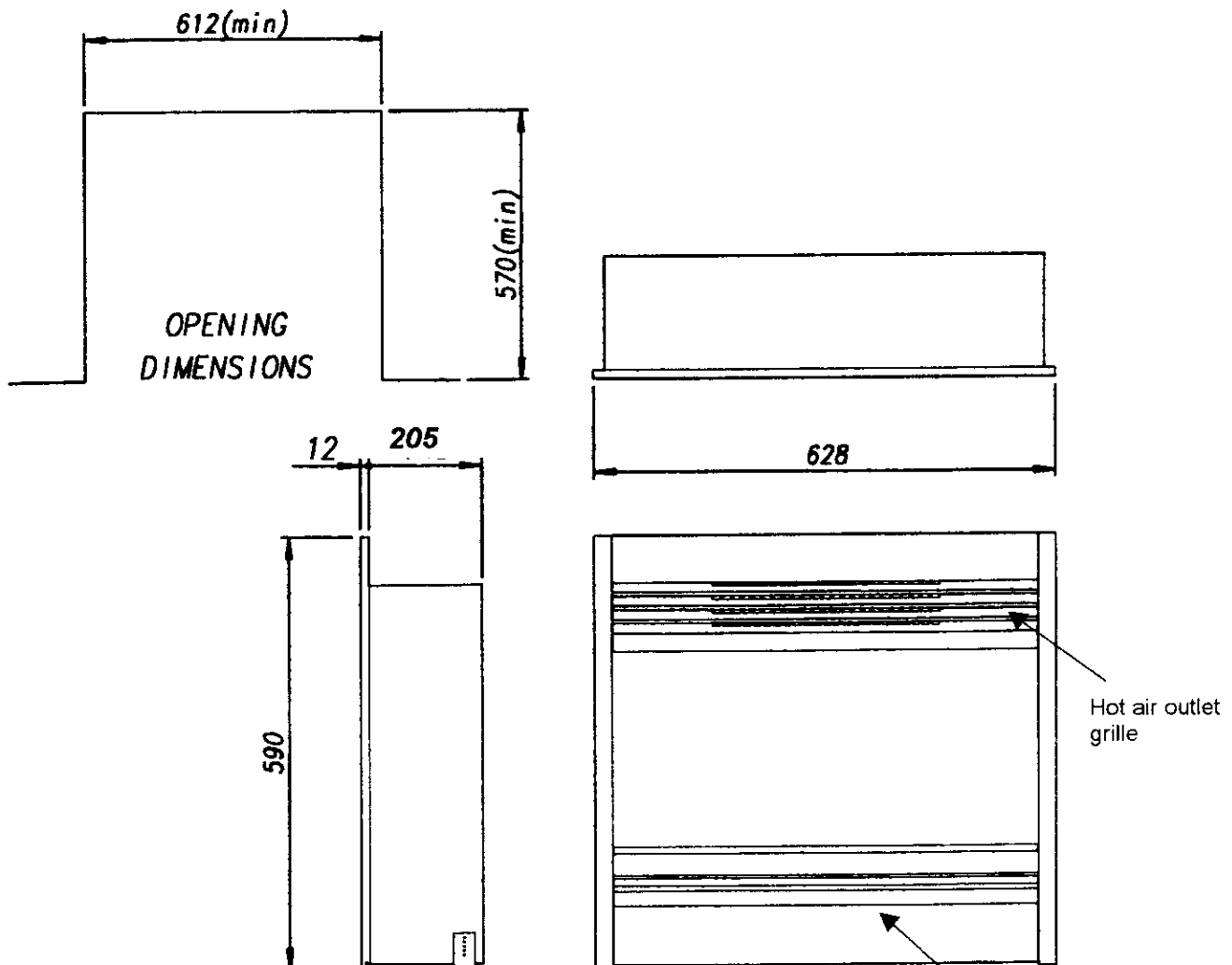

Fig. 1

Minimum opening dimensions in fire place:  
Height : 570mm  
Width : 612mm  
Depth : 205mm

Ash-pan flap, control cover  
contains lamp holder tray.

Hot air outlet  
grille

## Installation Instructions

**Ensure that all packaging items are removed (read any warning labels carefully).**

**Retain all packaging until installation is complete.**

## Preparation for use

This heater must be used on an AC~ supply only and the voltage marked on the heater must correspond with the supply voltage.

## Important Safety Advice:

### **Warning: This appliance must be earthed**

When using electrical appliances, Basic precautions should always be followed to reduce the risk of fire, electrical shock, and injury to persons, including the following:

- If the appliance is damaged, check with the supplier before installation and operation.
- Do not use outdoors.
- Do not use in the immediate surroundings of a bath, shower or swimming pool.
- Do not locate the heater immediately below a fixed socket outlet or connection box.
- Do not cover the heater. Do not place material or garments on the heater, or obstruct the air circulation around the heater, for instance by curtains or furniture, as this could cause overheating and a fire risk.
- The appliance is not intended for use by young children or infirm persons without supervision.
- Young children or infirm persons should be supervised to ensure that they do not play with the appliance.
- Do not use this heater in series with a thermal control, a program controller, a timer or any other device that switches on the heat automatically, since a fire risk exists when the heater is accidentally covered or displaced.
- Ensure that furniture, curtains or other combustible material are positioned no closer than 1 metre from the heater.
- In the event of a fault unplug the heater.
- Unplug the heater when not required for long periods.
- Although this heater complies with safety standards, we do not recommend its use on deep pile carpets or on long hair type of rugs.
- The appliance must be positioned so that the plug is accessible.
- If the supply cord is damaged it must be replaced by the manufacturer or service agent or a similarly qualified person in order to avoid a hazard.

## Operation

The controls are located behind the hinged ash-pan flap control cover. See Fig 2.

Connect the fire to your electricity supply.

### Flame Effect:

Press  switch to 'ON' position (A switch is in the 'ON' position when the red indicator mark on the Switch is visible). The flame effect will now operate.

### Heating Unit:

You have a choice of low heat 1000W or high heat 2000W output.

Both settings have thermostat temperature control. In order to operate the heating, switch  must be in the 'ON' position. See Fig 3.

### Low Heat Setting.

With switch  in the 'ON' position, press switch '=' to 'ON'.

### High Heat Setting.

With switches  and '=' in the 'ON' position, press Switch '=' to 'ON'.

The 2000W heat output is controlled by the thermostat which should be set to position 3. (See 'Thermostat operation').

The thermostat regulates the heat output according to user needs. To set the temperature you require, turn the temperature knob to position 3. If after a period of time you require more heat turn the knob to position 4. If after a period of time you require more heat turn the knob to a higher setting, or further reductions in heat output may be obtained by turning the knob to lower settings (fig.3).

### Thermal Safety Cut-Out.

A thermal safety cut-out is incorporated in the heater to prevent damage due to overheating.

This can happen if the heat output was restricted in any way. The heater will switch on once the obstruction has been removed and the heater has cooled. If the cut-out continues to operate intermittently, the heater should be switched off and a service agent contacted.

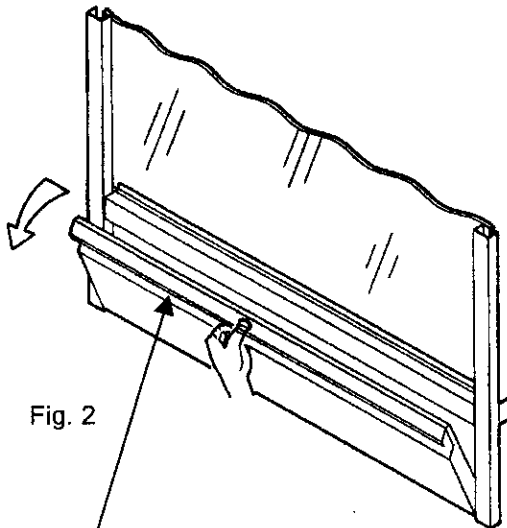
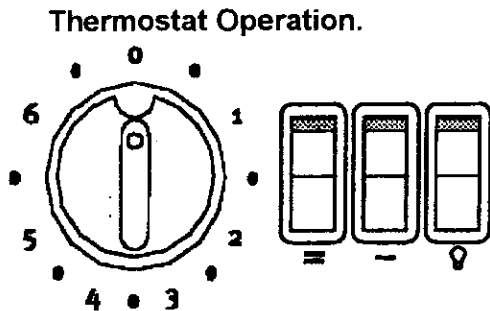

Fig. 2

Open the ash-pan flap  
For access to controls



Thermostat

Fig.3

## Maintenance

**Warning: Always disconnect before attempting any maintenance.**

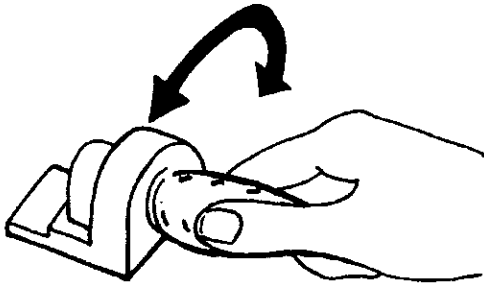

Atb 7

Fig 4.

### Lamp replacement

To gain access to the lamps, open the ash-pan flap.

Carefully slide out the lamp-holder tray. (see fig 1).

Unscrew the defective lamp anti-clockwise until it comes out of its holder. (see fig 4).

Replace the lamp with 240V, 40 watt E14 SES clear candle lamp, rotating the lamp clockwise in The holder until it is fully home. Do not over-tighten . Refit the lamp-holder tray.

### Cleaning.

Before commencing cleaning, unplug the heater and allow it to Cool.

The surface of the heater should be given an occasional wipe over with a soft damp cloth. Do not use detergents, abrasive cleaning powder or polish on the body of the heater.

The viewing screen should be cleaned carefully with a chamois leather DO NOT use proprietary glass cleaners.

### After sales service.

Your fuel effect fire is guaranteed for one year from the date of purchase. We undertake to Exchange or repair free of charge within this period, any part (with the exception of a lamp bulb) found to be defective due to a manufacturing fault.

Should you require After Sales Service, please get in touch with the supplier through whom you purchased the appliance.

Please do not initially return a faulty appliance or part of an appliance to us as this may result in transit damage and /or delay in providing service.

Let us know your difficulty, quoting the model number and series letter of the appliance. We will then take the appropriate action.



The product complies with the Australian/New Zealand Safety Standards AS/NZ S 335.2.30:1997 and also the European Standard Electromagnetic Compatibility (EMC) EN 55 014-1:1993, EN 61000-3-2:1995, EN 61000-3-3:1995, EN 55 014-2:1997 which cover the essential requirements of EEC Directive 89/336/EEC.

MONACO CORP. LTD (EURO)  
10 Rothwell Ave.  
Albany  
Auckland  
New Zealand